

Ø 1½" - Ø 4" Medium Bore Air Cylinders

- Available in 1½", 2¼", 2½", 3" and 4" bore diameter.
- Proven performance in a wide range of applications.
- Offered with a range of mountings and attachments.
- Features like single acting, double ended, reed switch type are also offered.
- Cylinders offered with stroke lengths upto 2000 mm with provision of stop tube if required.

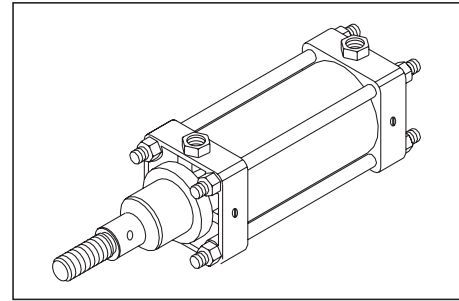

PART LIST

NO.	DESCRIPTION	QTY.
1	Front cover	1
2	Rear cover	1
3	Tube	1
4	'O' ring for cover	2
5	Wear ring	1
6	'U' cup seal for piston	2
7	Piston	2
8	'O' ring for piston	1
9	Tie rod nut	8
10	Tie rod	4
11	Lock nut	1
12	Bush bearing	1
13	Rod cum wiper seal	1
14	Piston rod	1
15	'O' ring for bleed screw	2
16	Bleed screw	2
17	Lock nut	2
18	Cap	2
19	Cushioning seal	2
20	Sleeve	2
21	'O' ring for sleeve	2
22	Check screw	2
23	'O' ring for check screw	2
24	Piston rod nut	1
25	Spring	2
26	Ball	2
27	Lock nut	1

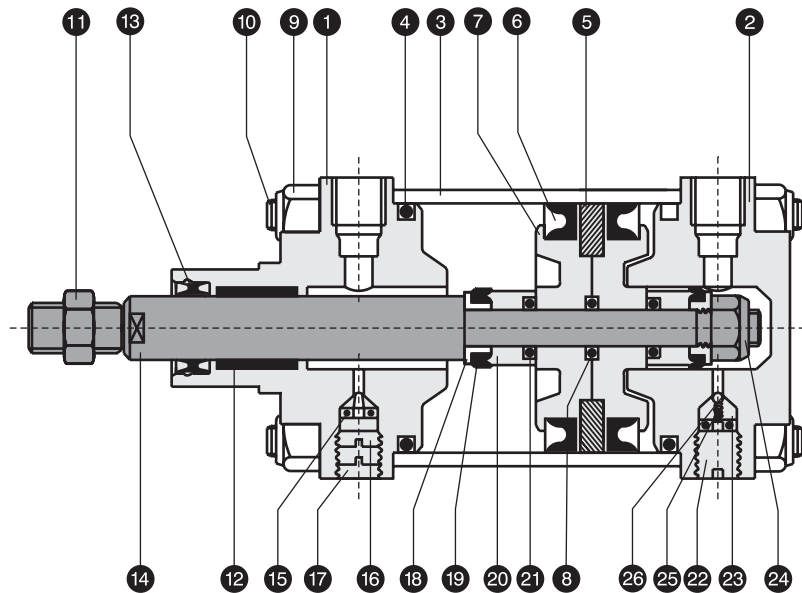

Seal kit consists of items 4, 6, 8, 11, 13, 15, 19, 21 & 23.

SPECIFICATIONS

Medium	Compressed Air, Filtered
Design	Pneumatic piston cylinder with adjustable cushioning at both ends
Max. operating pressure	10 bar
Temperature range	-10° C to 85° C (180° C for viton seals)
Material	a) End Covers : Aluminium b) Piston Rod : EN8 Hard chrome plated (Stainless steel optional) c) Cylinder barrel : Hard anodized aluminium d) Seals : NBR (Viton optional)

Ø 1½" - 4" Medium Bore Cylinders

SCHRADER[®]
DUNCAN LIMITED

SPC-07

BASIC CYLINDER

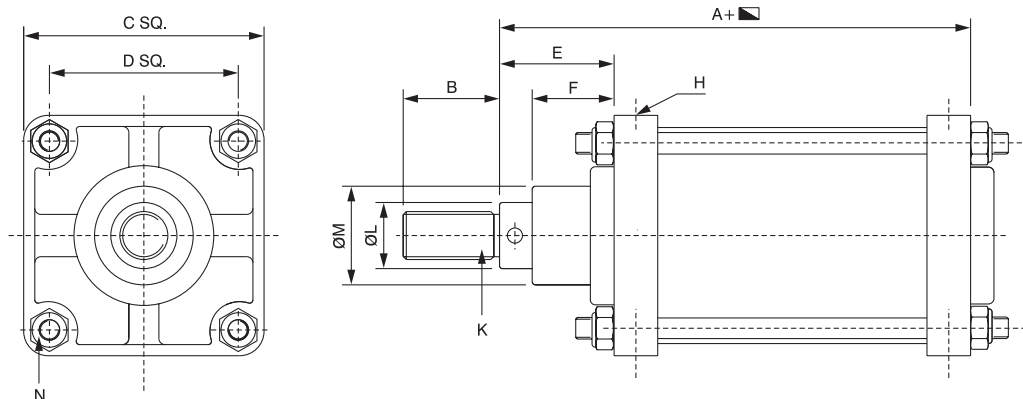

BORE SIZE	A mm	B mm	C SQ. mm	D SQ. mm	E mm	F mm	H BSP	K BSF	K METRIC ALTERNATE	Ø L mm	Ø M mm	N BSF
38 (1-1/2")	125	21	51	37	48	35	1/4"	1/2" - 16	M 12 X 1.5 P	16	30	1/4" - 26
57 (2-1/4")	125	21	70	53	48	35	1/4"	1/2" - 16	M 12 X 1.5 P	16	30	5/16" - 22
63 (2-1/2")	125	21	76	57	48	35	1/4"	1/2" - 16	M 12 X 1.5 P	16	30	5/16" - 22
76 (3")	150	31	89	67	61	43	3/8"	3/4" - 12	M 20 X 1.5 P	25	43	3/8" - 20
102 (4")	150	31	112	86	61	43	3/8"	3/4" - 12	M 20 X 1.5 P	25	43	3/8" - 20

- Cylinder is offered with BSF threading as standard. For metric threadings on piston rod as per 'ALTERNATE' please specify while ordering.
- Heavy duty cylinders in ϕ 102mm (4") with 1-3/8" piston rod are also offered.
- Please refer data sheet no. SPC-10 for single acting / double ended cylinder.
SPC-08 for Reed switch cylinder.

PISTON THRUST CHART (Theoretical)

BORE SIZE		AIR PRESSURE (BAR)										FREE AIR CONSUMPTION IN ϕ 25mm STROKE @ 7 BAR PR.
		1	2	3	4	5	6	7	8	9	10	
		THRUST AVAILABLE (KGF)										
38 (1-1/2")	PUSH	11.4	22.8	34.2	45.6	57	68.4	79.8	91.2	102.6	114	0.22
	PULL	9.4	18.8	28.2	37.6	47	56.4	65.8	75.2	84.6	94	0.184
57 (2-1/4")	PUSH	25.6	51.2	76.8	102.4	128	153.6	179.2	204.8	230.4	256	0.504
	PULL	23.6	47.2	70.8	94.4	118	141.6	165.2	188.8	212.4	236	0.465
63 (2-1/2")	PUSH	31.7	63.4	95.1	126.8	158.5	190.2	221.9	253.6	285.3	317	0.625
	PULL	29.6	59.2	88.8	118.4	148	177.6	207.2	236.0	266.4	296	0.568
76 (3")	PUSH	45.6	91.2	136.8	182.4	228	273.6	319.2	364.8	410.4	456	0.9013
	PULL	40.6	81.2	121.8	162.4	203	243.6	284.2	324.8	365.4	406	0.804
102 (4")	PUSH	81.0	162	243	324	405	486	567	648	729	810	1.60
	PULL	76.1	152.2	228.3	304.4	380.5	456.6	532.7	608.8	684.9	761	1.53

NOTE :

To decide cylinder bore size :

- Establish force required and working pressure available.
- Select working pressure on top of the chart.
- Select force required by reading down from selected working pressure.
- Read out cylinder bore size on left of the chart.

EXAMPLE : If it is established that the force required is 150 Kg. and working pressure available is 7 bar, above chart will lead you to select 2 1/4" bore cylinder.

DOUBLE TRUNNION MOUNTING

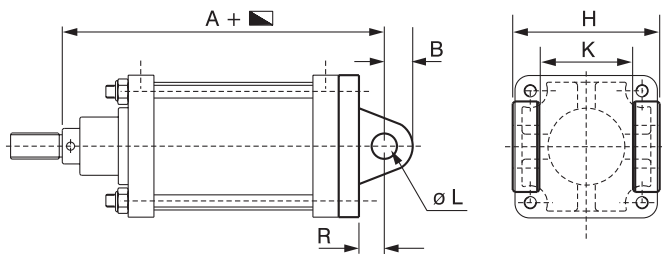

CYLINDER BORE	MTG. PART NO.	A mm	B mm	H mm	K mm	ØL mm	R mm
38 (1-1/2")	0101	150	12.7	54	32	12.7	16
57 (2-1/4")	0201	150	12.7	73	45	12.7	16
63 (2-1/2")	0A01	150	12.7	83	51	12.7	16
76 (3")	0301	183	19	92	57	19	22
102 (4")	0401	183	19	114	76	19	22

REAR PLATE MOUNTING

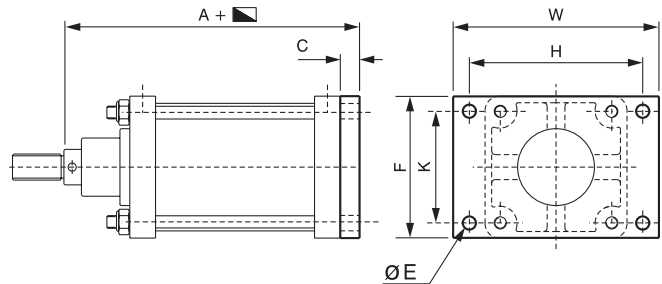

CYLINDER BORE	MTG. PART NO.	A mm	C mm	ØE mm	F mm	H mm	K mm	W mm
38 (1-1/2")	0103	134	10	7	51	67	37	83
57 (2-1/4")	0203	134	10	8	70	89	52	108
63 (2-1/2")	0A03	134	10	8	76	95	57	114
76 (3")	0303	163	13	10	89	111	67	163
102 (4")	0403	163	13	10	111	133	86	163

SINGLE TRUNNION MOUNTING

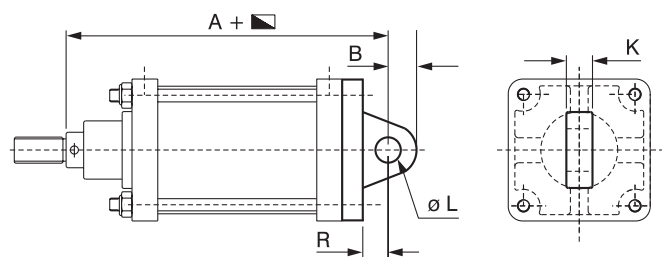

CYLINDER BORE	MTG. PART NO.	A mm	B mm	K mm	L mm	R mm
38 (1-1/2")	0108	158	12.7	19	12.7	16
57 (2-1/4")	0208	156	12.7	19	12.7	16
63 (2-1/2")	0A08	156	12.7	19	12.7	16
76 (3")	0308	192	19	25.4	19.1	22
102 (4")	0408	192	19	31.8	19.1	22

CENTRE TRUNNION MOUNTING

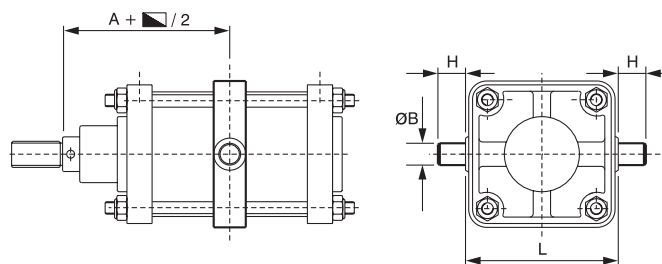

CYLINDER BORE	MTG. PART NO.	A mm	B mm	H mm	L mm
38 (1-1/2")	0105	86	19	25.4	60.4
57 (2-1/4")	0205	86	19	25.4	85.7
63 (2-1/2")	0A05	86	22	29.5	89.4
76 (3")	0305	105	25.4	29.5	103
102 (4")	0405	105	25.4	31.8	149.5

LEG MOUNTING

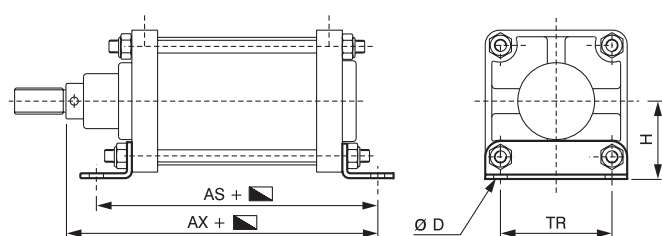

CYLINDER BORE	MTG. PART NO.	ØD mm	H mm	AS mm	AX mm	TR mm
38 (1-1/2")	0107	7	31	121	146	37
57 (2-1/4")	0207	9	40	127	149	52
63 (2-1/2")	0A07	9	42	127	149	57
76 (3")	0307	10	48	141	175	67
102 (4")	0407	10	57	141	175	86

FRONT PLATE MOUNTING

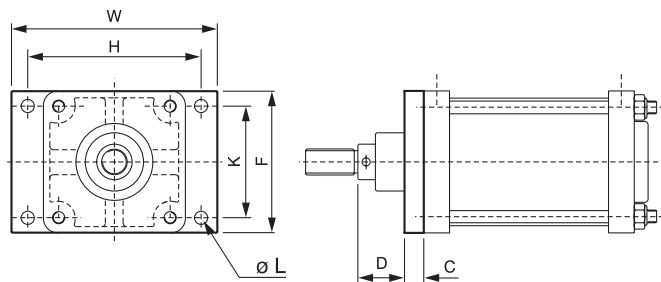

CYLINDER BORE	MTG. PART NO.	C mm	D mm	F mm	H mm	K mm	ØL mm	W mm
38 (1-1/2")	0104	10	39	51	67	37	7	83
57 (2-1/4")	0204	10	39	70	89	52	8	108
63 (2-1/2")	0A04	10	39	76	95	57	8	114
76 (3")	0304	13	49	89	111	67	10	134
102 (4")	0404	13	49	111	133	86	10	153

FRONT TRUNNION MOUNTING

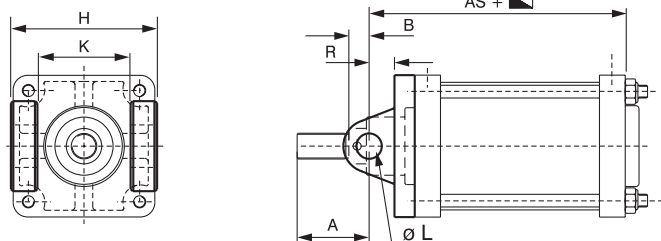

CYLINDER BORE	MTG. PART NO.	A mm	B mm	H mm	K mm	ØL mm	R mm	AS mm
38 (1-1/2")	0102	44	12.7	54	32	12.7	16	102.4
57 (2-1/4")	0202	44	12.7	73	45	12.7	16	102.4
63 (2-1/2")	0A02	44	12.7	82	51	12.7	16	102.4
76 (3")	0302	57	19	92	57	19	22	123
102 (4")	0402	57	19	115	76	19	22	123

DOUBLE TRUNNION WITH HINGE MOUNTING

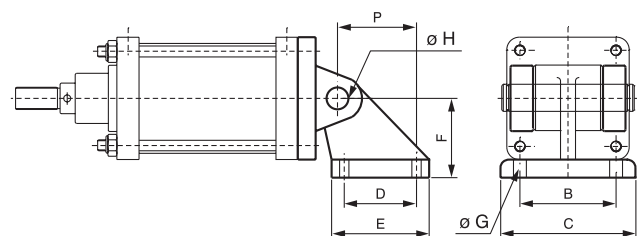

CYLINDER BORE	MTG. PART NO.	B mm	C mm	D mm	E mm	F mm	ØG mm	ØH mm	P mm
1-1/2"	HNG-1.5	41	54	22	35	36	6.6	12.7	24
2-1/4"	HNG-2.25	50	65	30	45	45	9	12.7	33
2-1/2"	HNG-2.5	52	67	35	50	50	9	12.7	37
3"	HNG-3	66	86	40	60	63	11	19	47
4"	HNG-4	76	96	50	70	71	11	19	55

ORDERING INFORMATION

CYL. TYPE	BORE SIZE	CUSHIONING / PISTON ROD MTL./SEAL MTL.	MOUNTING & FORK	STROKE IN INCHES
C = Inch Series	1/2" = A1	Cushioned/En8/NBR = 1	MTG. ONLY	095 mm = 095
D = Sp. cyl. in inch series	3/4" = A2	Cushioned/En8/Viton = 2	0 = Basic	220 mm = 220
	1" = A3	Cushioned/S.S/NBR = 3	1 = Rear Trunnion	2.78" = 071
	1-1/2" = 01	Cushioned/S.S/Viton = 4	2 = Front Trunnion	8" = 203
	2-1/4" = 02	Non cushioned/En8/NBR = 5	3 = Rear Flange	
	2-1/2" = 0A	Non cushioned/En8/Viton = 6	4 = Front Flange	
	3" = 03	Non cushioned/S.S/NBR = 7	5 = Centre Trunnion	
	4" = 04	Non cushioned/S.S/Viton = 8	7 = Leg Mounting	
			8 = RT Mtg. with Hinge Bracket	
			9 = Single Trunnion	

Typical Example : 2-1/2" X 2.73" cushioned cylinder with Rear trunnion mounting having S.S. piston rod and viton seals : C0A41069