

G 1/4 5/2, 3/2 High Flow Pilot Valves

- Streamlined construction.
- Contoured dynamic seals ensures longer life.
- Higher flow capacities.
- Facility of manifolding with 5/2 valves.

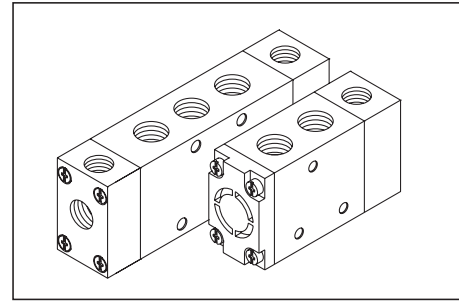

PART LIST - 5/2 WAY VALVES

NO.	DESCRIPTION	QTY.	
		Single Pilot	Double Pilot
1	Valve body	1	1
2	Spool	1	1
3	Spring housing	1	-
4	Spring	1	-
5	Spool seal	6	6
6	Gasket	1	-
7*	Base plate	1	1
8*	Sub base 'O' rings	5	5
9	Pilot housing	1	2
10	Plug for pilot housing	1	2
11	Piston 'O' ring	1	2

Seal kit consists of items (2+5), 6, 8 & 11
*(For Sub base valve only)

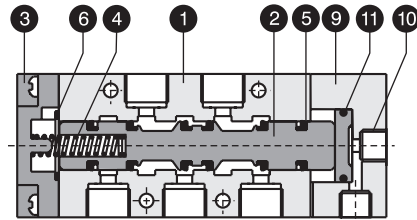

5/2 Single Pilot High Flow Valve

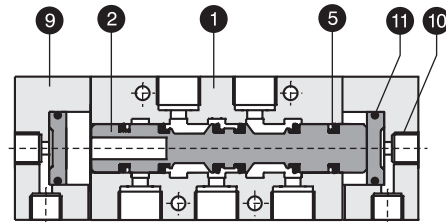

5/2 Double Pilot High Flow Valve

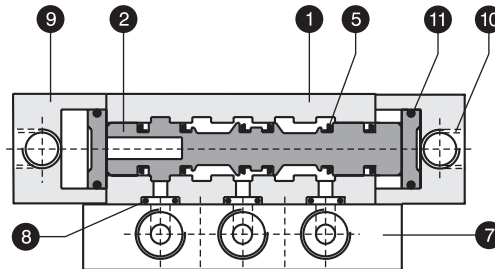

5/2 Double Pilot High Flow Valve (Sub base)

PART LIST - 3/2 WAY VALVES

NO.	DESCRIPTION	QTY.	
		Single Pilot	Double Pilot
1	Valve body	1	1
2	Spool	1	1
3	Spring housing	1	-
4	Spring	1	-
5	Spool seal	4	4
6	Gasket	1	-
7	Pilot housing	1	2
8	Plug for pilot housing	1	2
9	Piston 'O' ring (Pilot hsg.)	1	2

Seal kit consists of items (2+5), 6 & 9

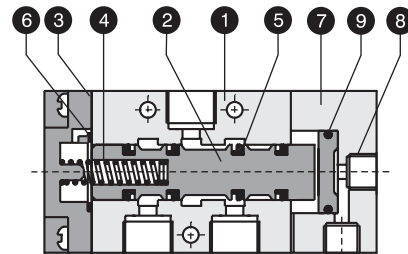

3/2 Single Pilot High Flow Valve

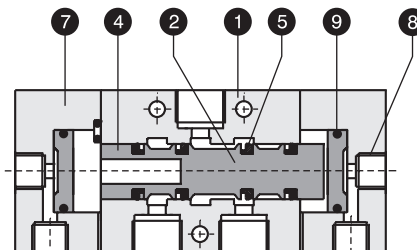

3/2 Double Pilot High Flow Valve

G 1/4 5/2 & 3/2 SINGLE PILOT HIGH FLOW VALVE

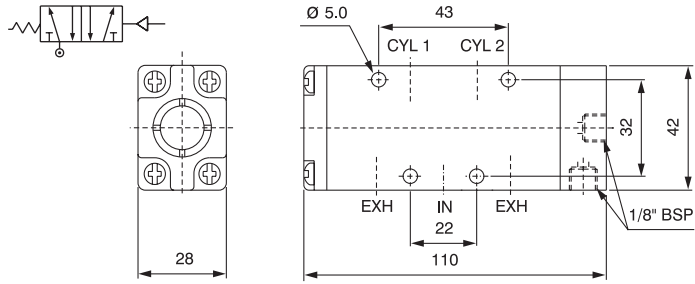

5/2 Single Pilot High Flow Valve

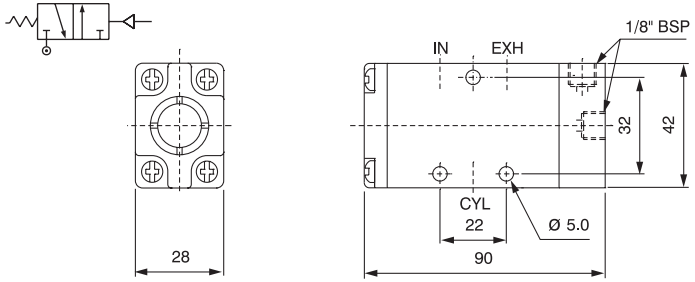

3/2 Single Pilot High Flow Valve

G 1/4 5/2 & 3/2 DOUBLE PILOT HIGH FLOW VALVE

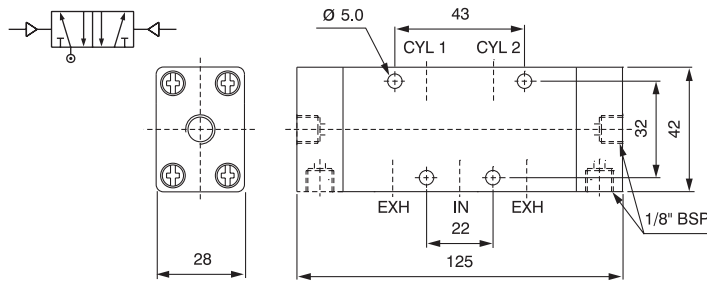

5/2 Double Pilot High Flow Valve

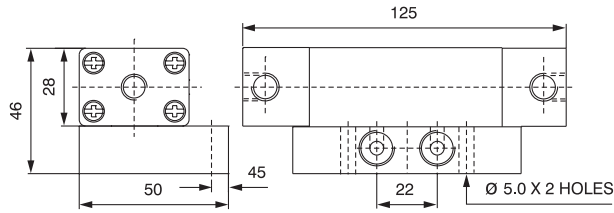

5/2 Double Pilot High Flow Valve (Sub base)

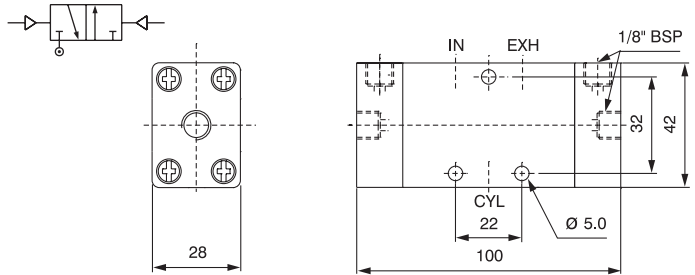

3/2 Single Pilot High Flow Valve

PART NOS.

Type	Side ported valve	Valve with sub base plate
G 5/2 Single pilot valve	43004 PS	43204 PS
G 3/2 Single pilot valve	43003 PS	-----

Type	Seal kit for Side ported valve	Valve with sub base plate
G 5/2 Single pilot valve	SK 43004	SK 43204
G 3/2 Single pilot valve	SK 43003	-----

SPECIFICATIONS

Medium	Compressed air, Filtered
Design	Spool type with air spring return
Working pressure	1.8 - 10 kg. / sq.cm.
Ambient / fluid temp.	- 10 to 55° C
Cv (Nominal flow)	1.3 (1300 lit. / min.)
Response time at 5 bar	On Time : 10 m.s. Off Time : 35 m.s.
Materials	Body & Spool : Aluminium Seals : NBR

PART NOS.

Type	Side ported valve	Valve with sub base plate
G 5/2 Double pilot valve	43204 PP	43204 PP
G 3/2 Double pilot valve	43203 PP	-----

Type	Seal kit for Side ported valve	Valve with sub base plate
G 5/2 Double pilot valve	SK 43004	SK 43204
G 3/2 Double pilot valve	SK 43003	-----

SPECIFICATIONS

Medium	Compressed air, Filtered
Design	Spool type with air spring return
Working pressure	1.8 - 10 kg. / sq.cm.
Ambient / fluid temp.	- 10 to 55° C
Cv (Nominal flow)	1.3 (1300 lit. / min.)
Response time at 5 bar	On Time : 20 m.s. Off Time : 35 m.s.
Materials	Body & Spool : Aluminium Seals : NBR