

G 3/8 G 1/2 - 5/2 High Flow Solenoid Valves

- Streamlined construction.
- Compact dynamic seal design results in higher flow passages.
- Available in side port design in G 3/8, G 1/2 sizes.
- Option of gang manifolding upto 6 nos. of valves.

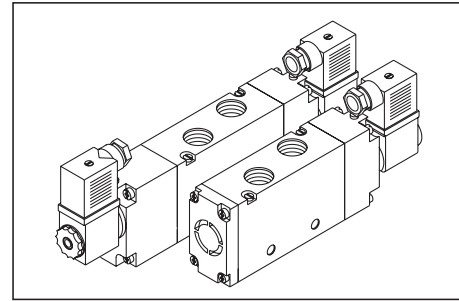

PART LIST

NO.	DESCRIPTION	QTY.	
		Single Sol.	Double Sol.
1	Valve Body	1	1
2	Spool	1	1
3	Solenoid Housing	1	2
4	Manual Override Pin	1	2
5	Air Spring Housing	1	-
6	Piston	1	2
7	Coil with plug in connector	1	2
8	Spool seal	6	6
9	Gasket	1	-
10	M.O. Pin 'O' Ring	1	2
11	Piston seal	1	2
12	'O' Ring for Sole. Hsg.	1	2
13	Spring	1	-

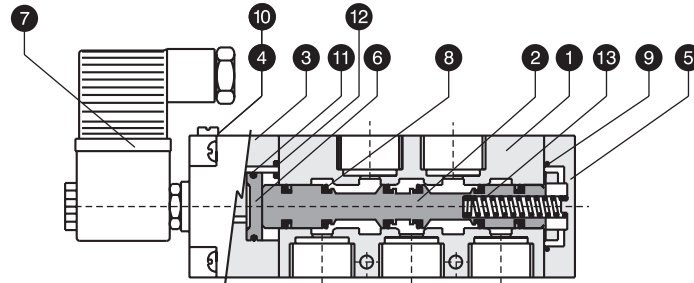

Single solenoid valve

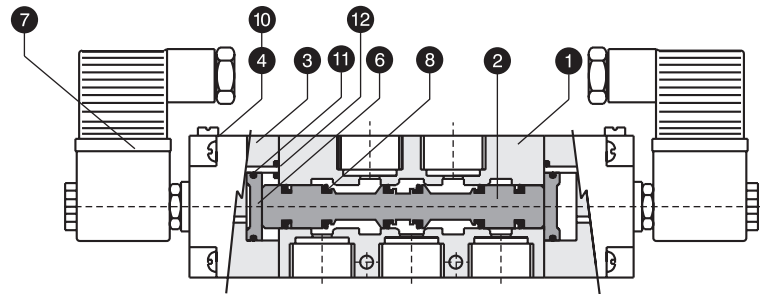

Double solenoid valve

Seal kit consists of items (2+8), 9, 10, 11 & 12

COIL SPECIFICATIONS

Type	Valve with G 25 coil	
Tube Assy. Construction	SS Plunger with NBR seals, SS magnet core assembled with brass adaptor	
Coil Voltages	AC : 24, 110, 240 V 50 Hz DC : 12, 24 V	(Other voltages on request AC : 12, 48 V 50 Hz DC : 48, 110 V)
Voltage Range	± 10%	
Power Consumption	AC : Pull : 7.5 VA, Hold : 5 VA DC : 3 WATT	
Duty cycle	100%	
Class of Insulation	F (Winding wire of class 'H' insulation)	
Degree of protection	IP 65 - IS 2147	
Cable connector	DIN 43650 - PG. 9	

PORT CONFIGURATION

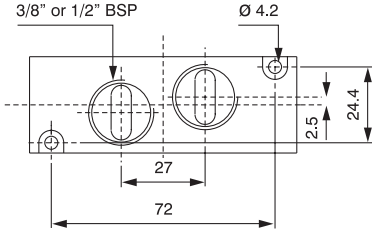

G3/8, 1/2 - 5/2 SINGLE SOLENOID SPOOL VALVE

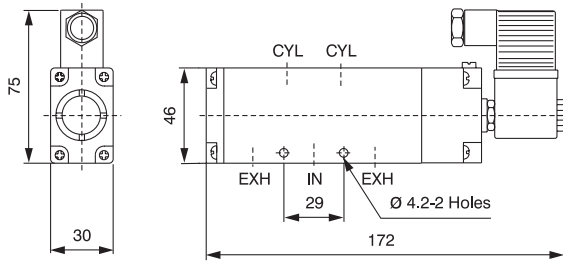
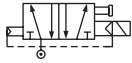

PART NOS.

Type	Part No.
3/8" 5/2 Single solenoid valve	A83014
1/2" 5/2 Single solenoid valve	A93014
Seal kit for 5/2 Single solenoid valve	SK 83004

SPECIFICATIONS :

Medium	Compressed Air, Filtered
Design	Spool type with air spring return
Working pressure	1.5 - 10 kg/sq.cm
Ambient / fluid temp.	- 10 to 55° C
Cv (Nominal flow)	2.2 (2200 lit. / min)
Response time at 5 bar	ON time : 10 m.s OFF time : 30 m.s
Manual Override	Screw type, detent
Optional features	PIC with light indicator. External pilot actuation.
Materials	Body & Spool : Aluminium Seals : NBR

G3/8, 1/2 - 5/2 DOUBLE SOLENOID SPOOL VALVE

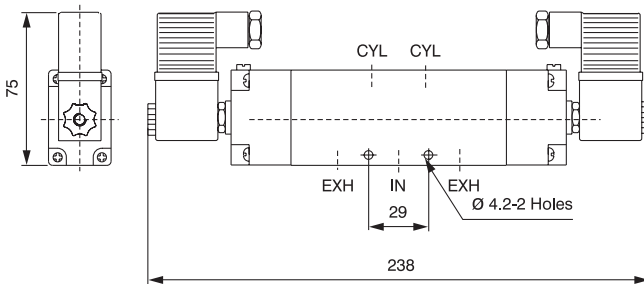
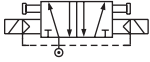

PART NOS.

Type	Part No.
3/8" 5/2 Double solenoid valve	A83024
1/2" 5/2 Double solenoid valve	A93024
Seal kit for 5/2 Double solenoid valve	SK 83024

SPECIFICATIONS :

Medium	Compressed Air, Filtered
Design	Spool type
Working pressure	1.5 - 10 kg/sq.cm
Ambient / fluid temp.	- 10 to 55° C
Cv (Nominal flow)	2.2 (2200 lit. / min.)
Response time at 5 bar	20 m.s
Manual Override	Screw type, detent
Optional features	PIC with light indicator. External pilot actuation.
Materials	Body & Spool : Aluminium Seals : NBR